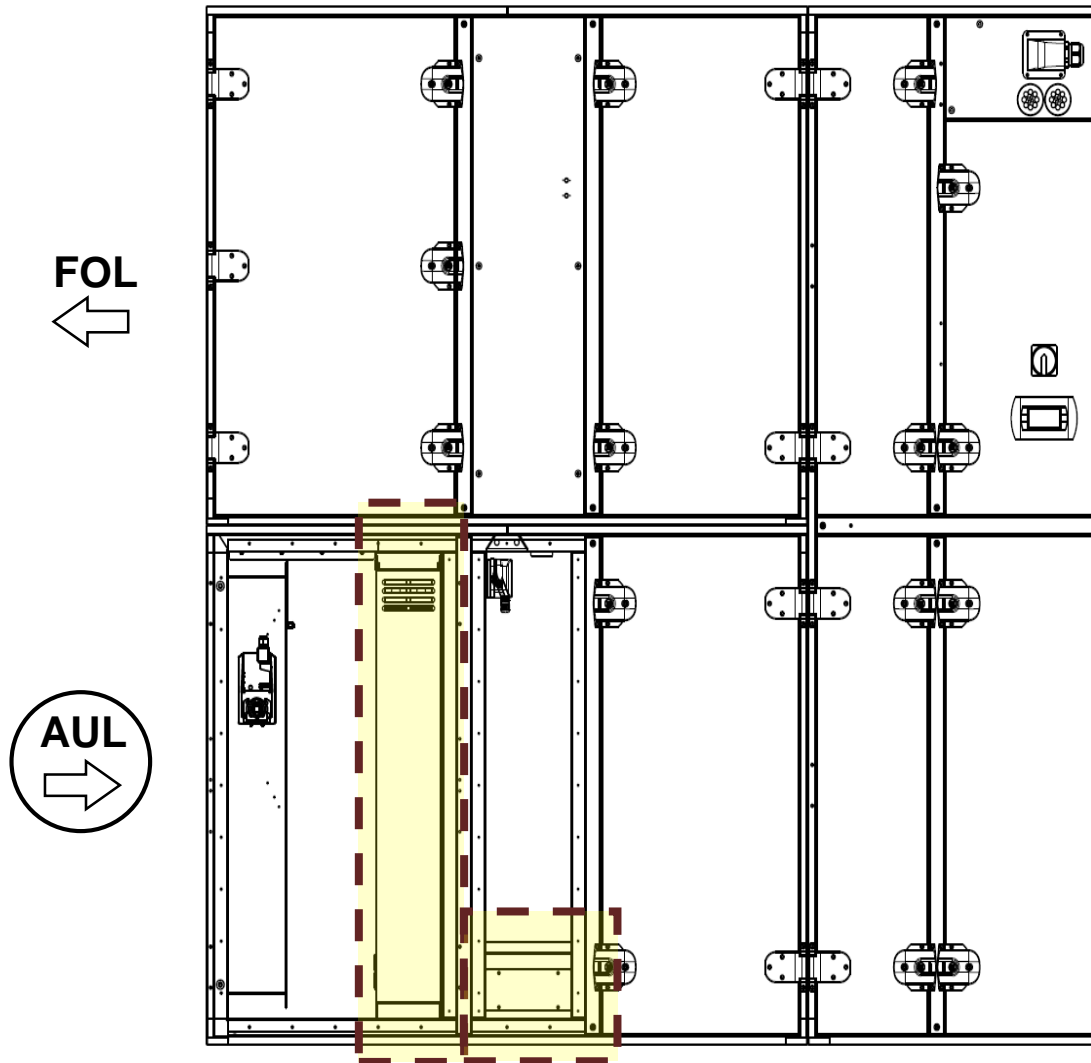

DE

Montageanleitung  
**ELEKTROREGISTER (FILTERVORTROCKNER)**  
**CRL-iH/A evo max**

Änderungen vorbehalten

**CRL-iH/A evo max  
Elektroregister (Filtervortrockner)**

Pos.	Menge	Bemerkung
1	1x	---
2	1x	---
3	1x	---
4	6x	5,5x13
5	4x	6,3x25 / SW9,5
6	4x	---
7	2x	Snap-Metric M20
	2x	Snap-Metric M32
8	1x	CRL-A evo max
	2x	CRL-iH evo max
9	8	CRL-A evo max ; 5,5x16
	16x	CRL-iH evo max ; 5,5x16

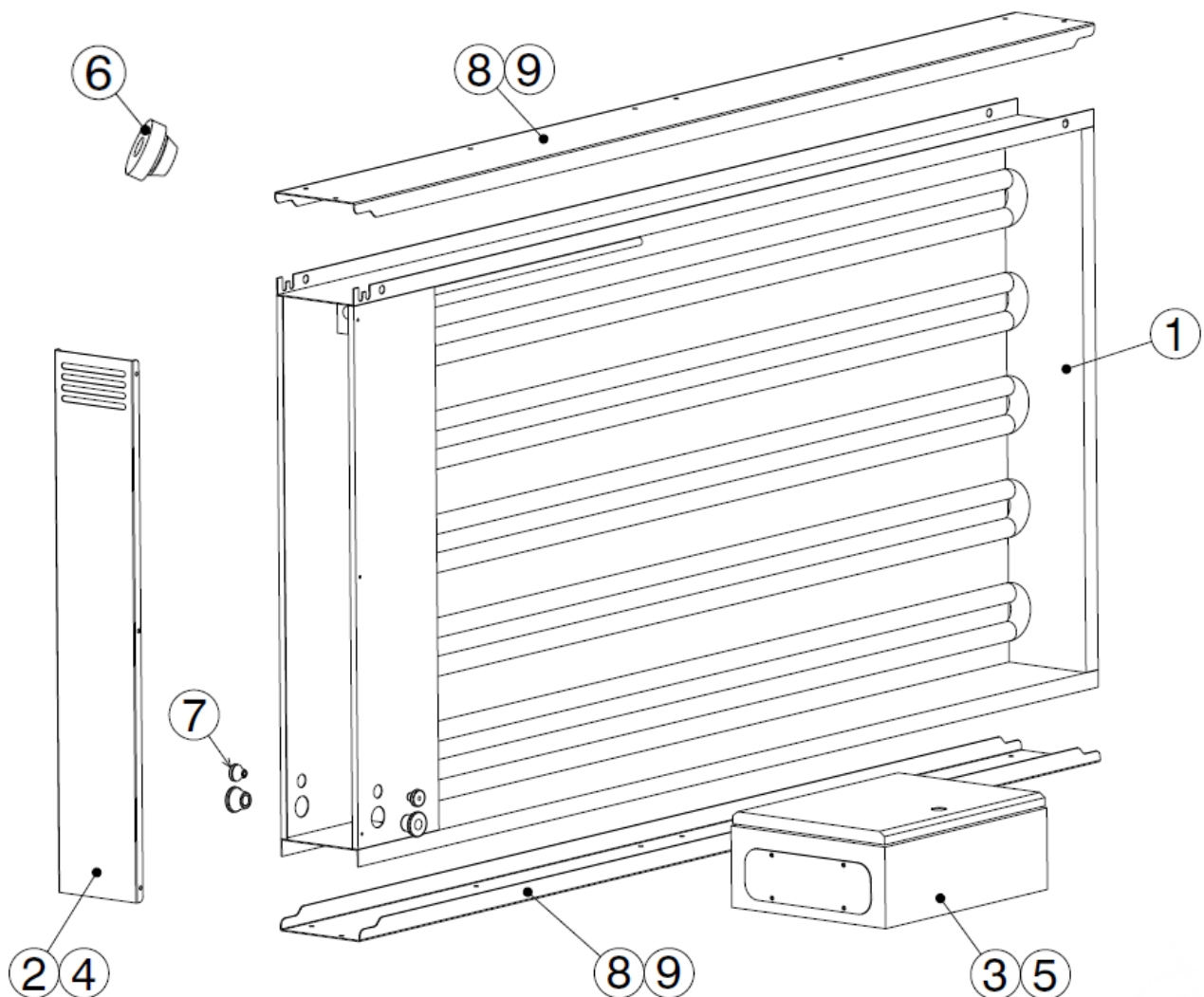

1.

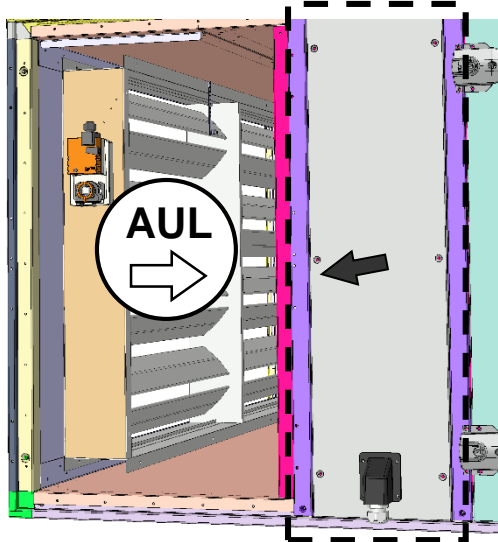

2.

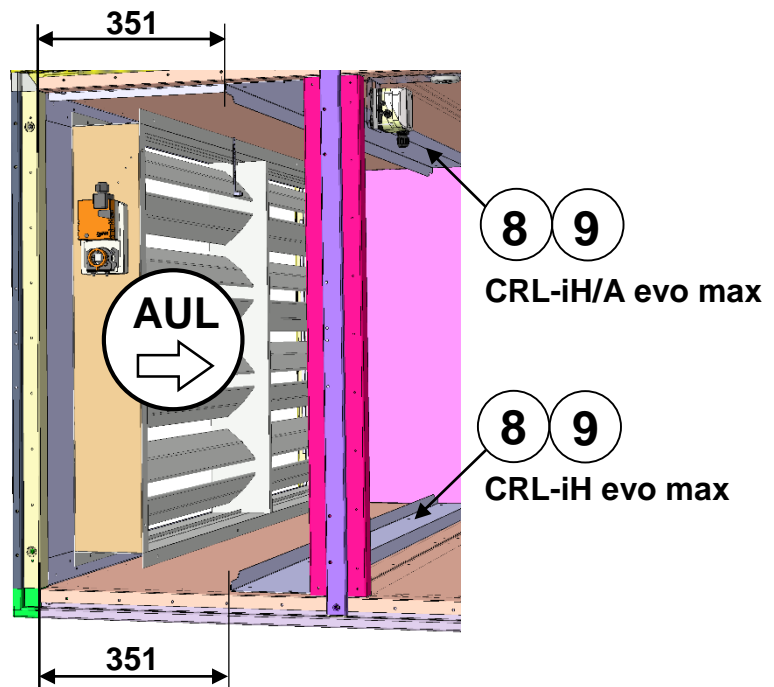

3.

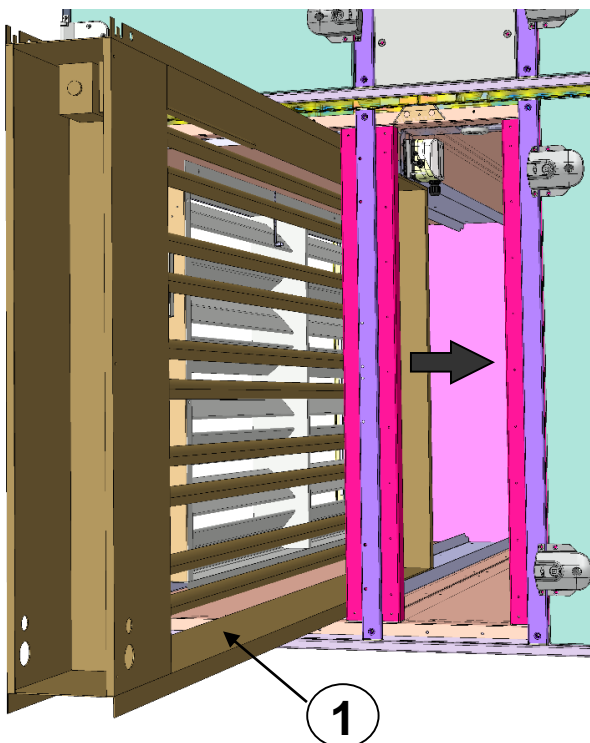

4.

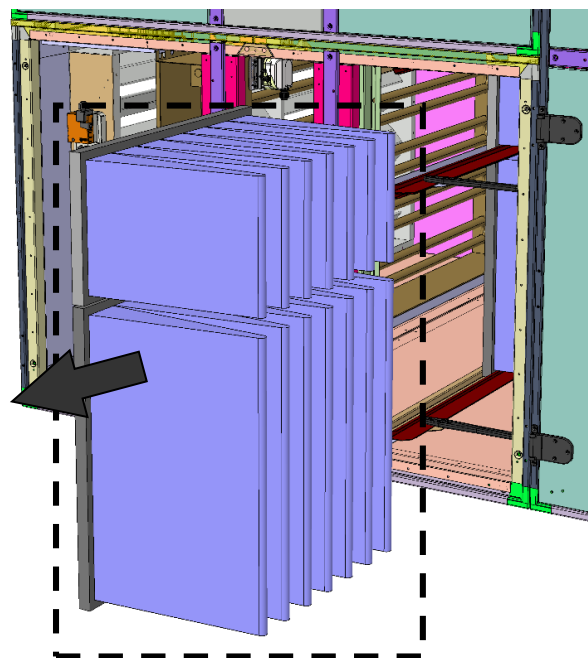

5.1

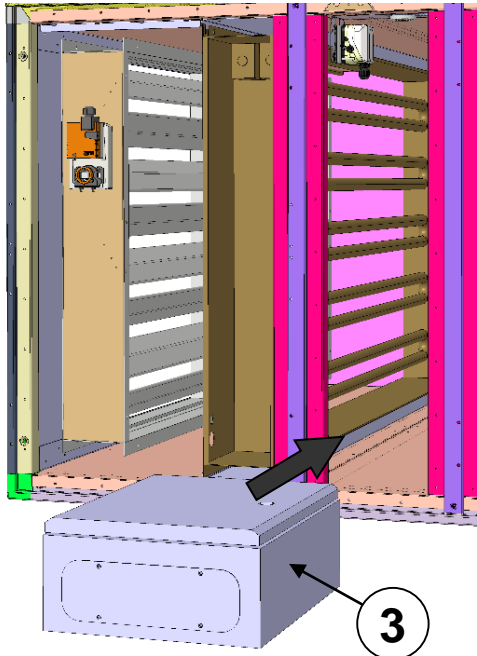

5.2

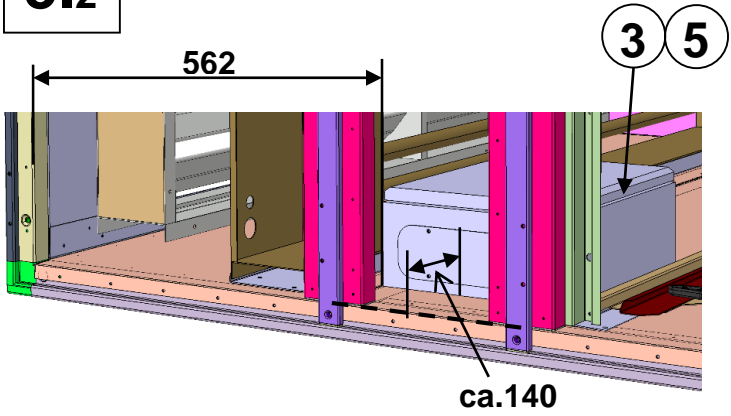

6.

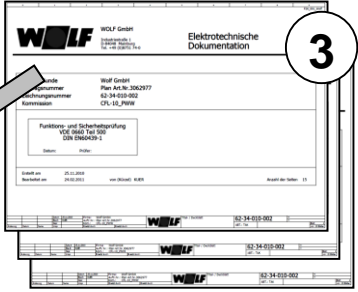
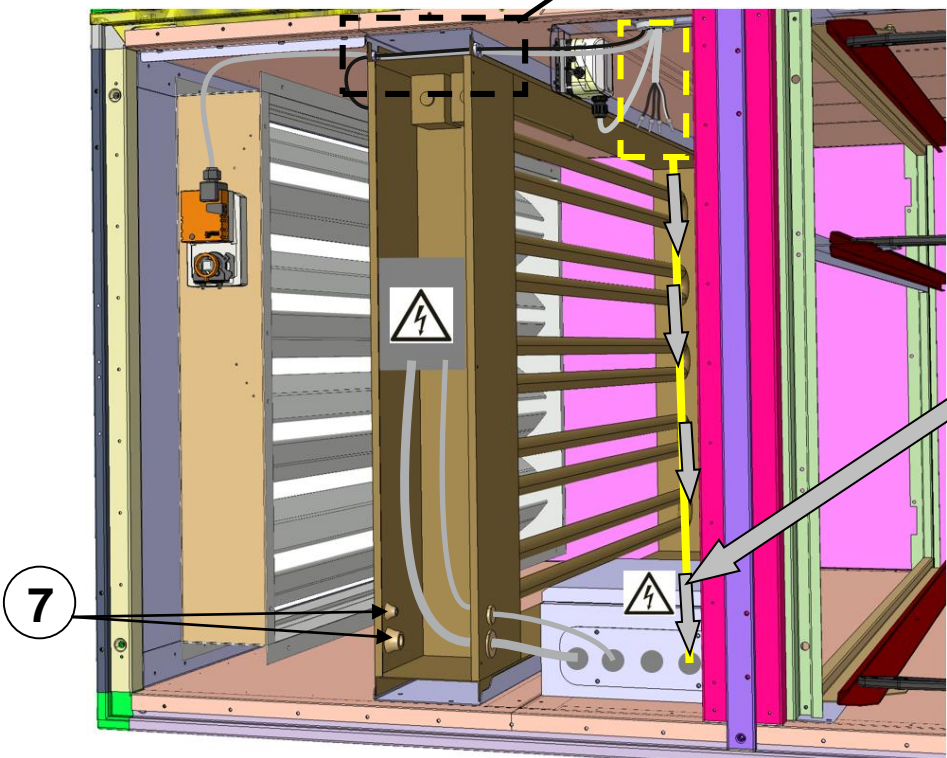
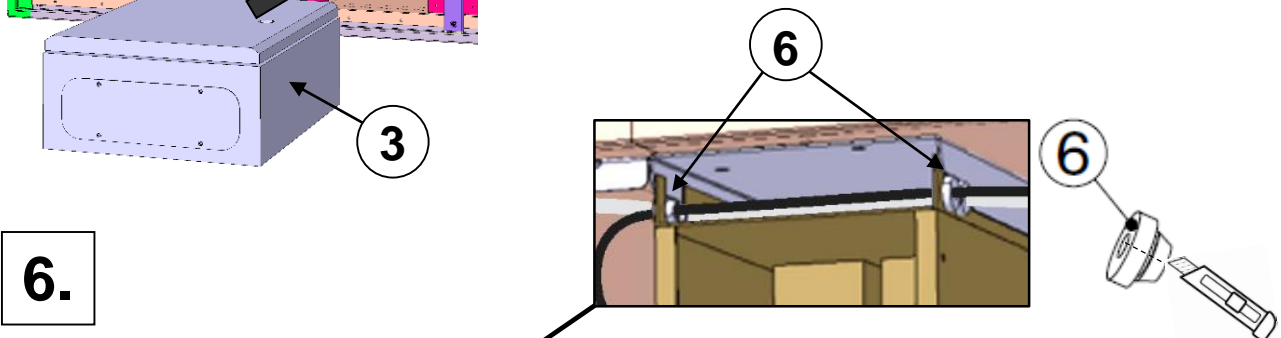

7.

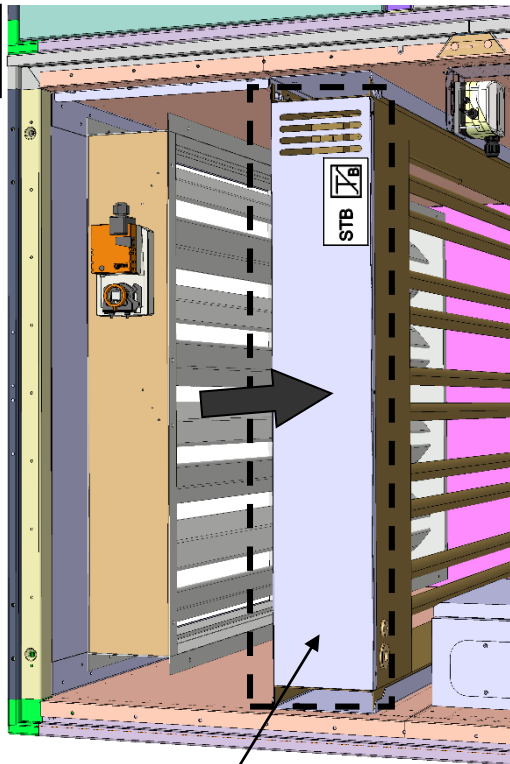

2 4

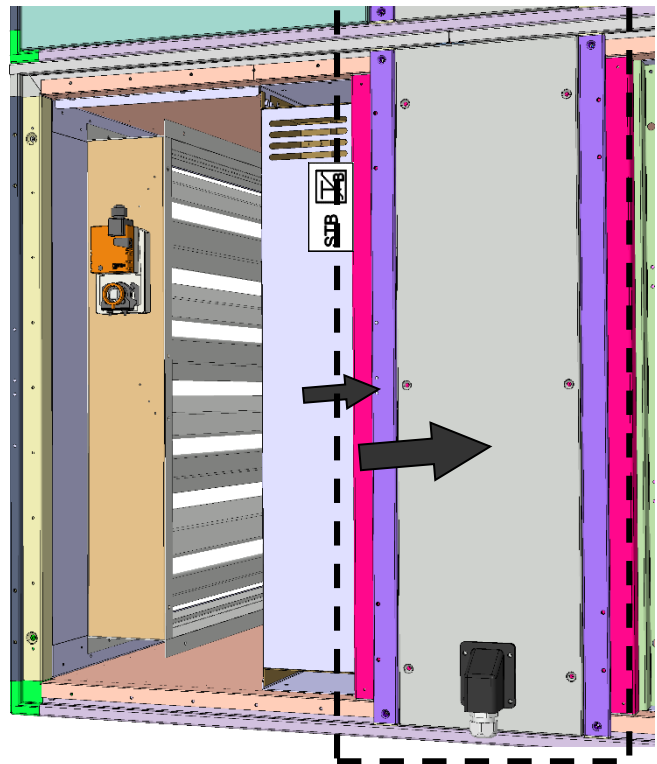

8.

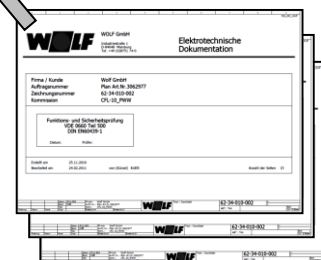
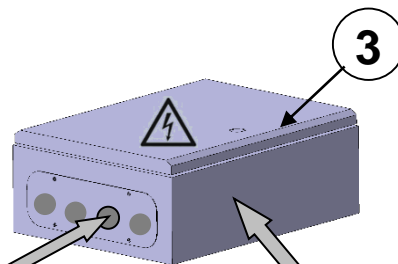
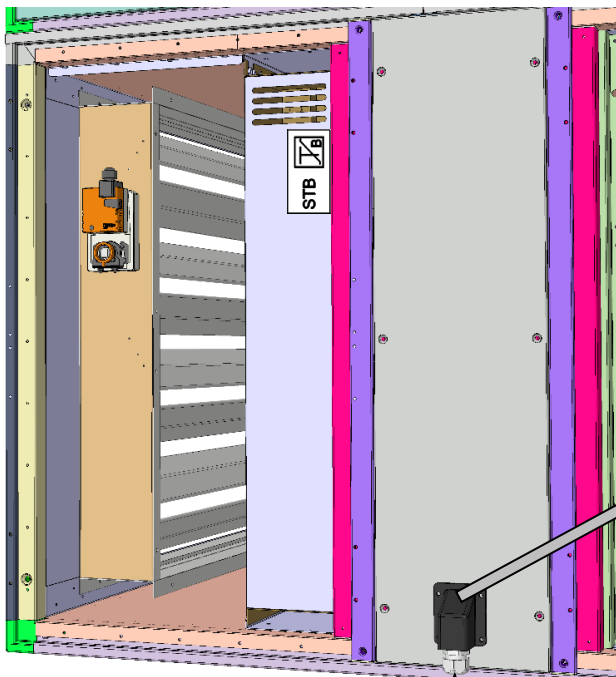



# Montageanleitung Elektroregister (Filtervortrockner) für CRL-iH/A evo max

---



## Montageanleitung Elektroregister (Filtervortrockner) für CRL-iH/A evo max

---

WOLF GmbH / Postfach 1380 / D-84048 Mainburg  
Tel. +49.0.87 51 74- 0 / Fax +49.0.87 51 74- 16 00 / [www.WOLF.eu](http://www.WOLF.eu)